

Option 1 אפשרות ראשונה

Installation on narrow rim helmet התקנה בקסדה עם מסגרת צרה
 <5mm

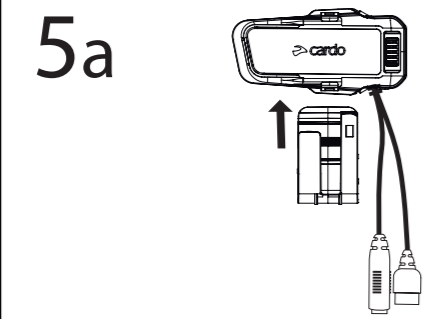

5b Push clamp into place לחץ את הקליפס פנימה

Option 2 אפשרות ראשונה

Installation on wide rim helmet התקנה בקסדה עם מסגרת רחבה
 >5mm

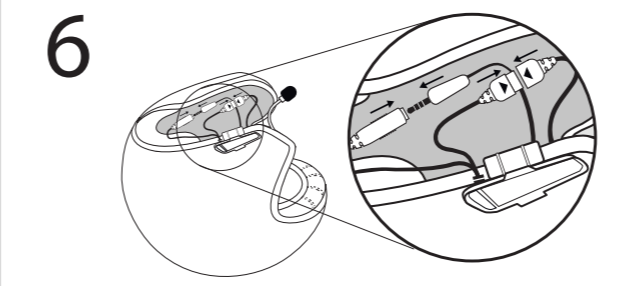
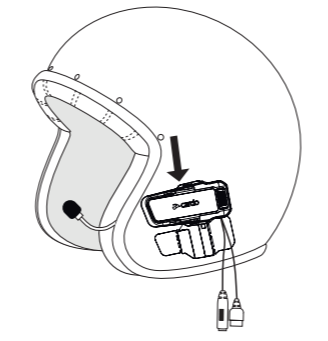
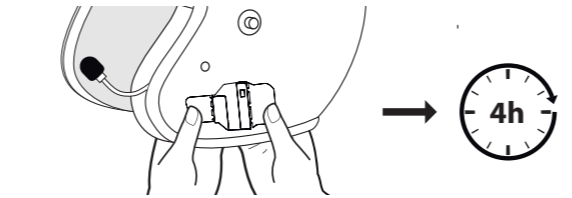
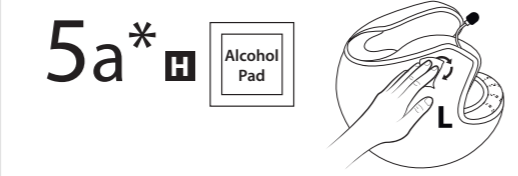

7 Tuck wires behind padding מקם כבלים מאחורי ריפוד הקסדה

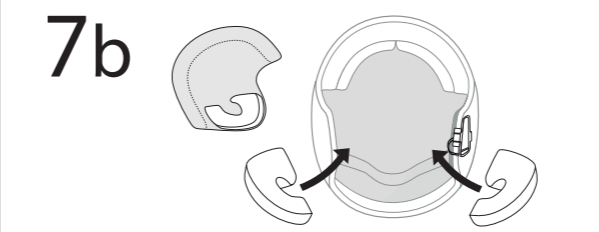

8 Optional G ● x2 If needed, use booster pads to place speakers closer to ear במידת הצורך ניתן להשתמש בכריות הגבהה

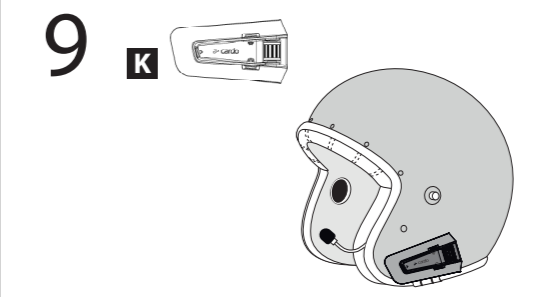
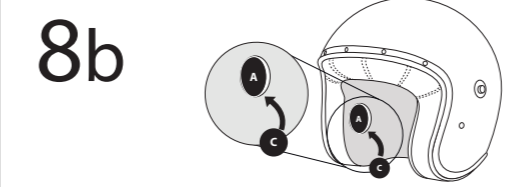
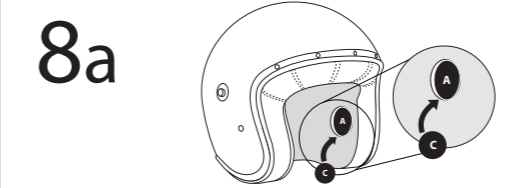

10 K Remove the unit הסר את היחידות

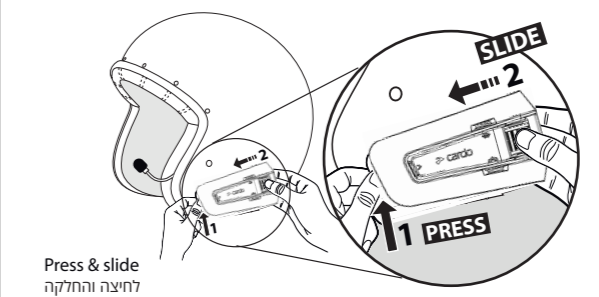

Press & slide לחיצה והחלקה

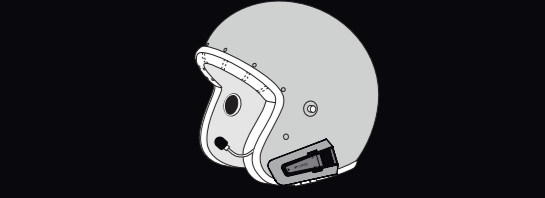
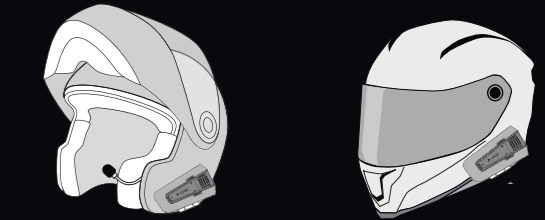

PACKTALK EDGE
 Installation Guide
 הוראות התקנה

INSTALLATION VIDEO

סרטון התקנה



CONTENTS תכולה

- A** x2 Velcro סקוץ' עגול
- B** x2 Velcro סקוץ' מלבני
- C** x2 Booster כרית הגבהה
- D** מיקרופון נסתר

- E** מיקרופון בום
- F** רמקולים
- G** בסיס לדיבורים

- H** סד אלכוהולי
- I** תושבת הדבקה
- J** קליפס
- K** דיבורים

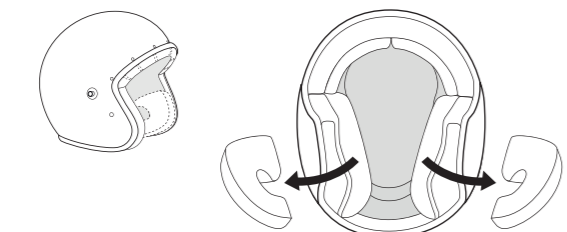
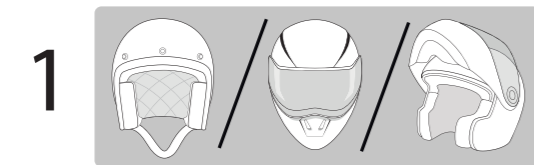

2 **A** x2

2a **A**

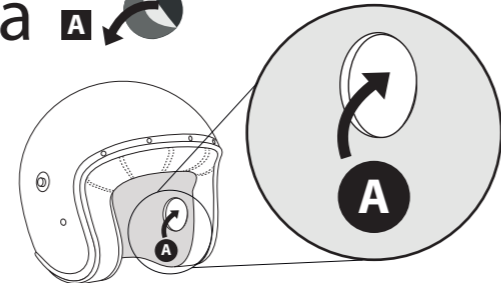

2b **A**

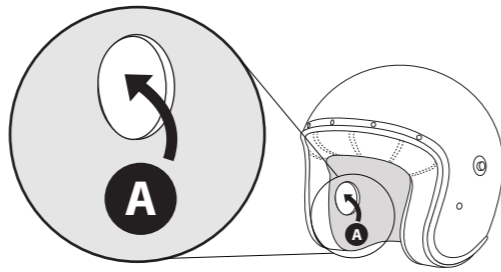

3 **E** L R

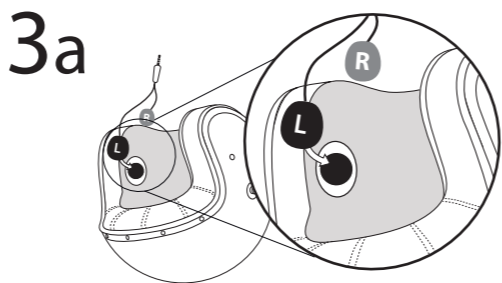

3b

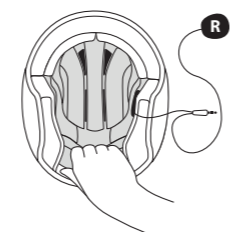

3c

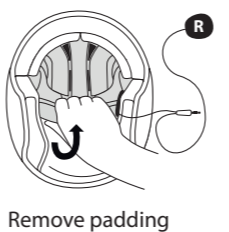

3d

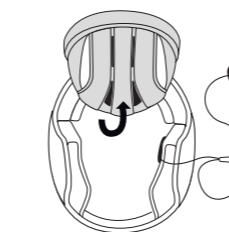

3e

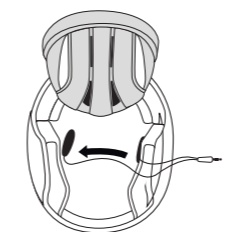

3f

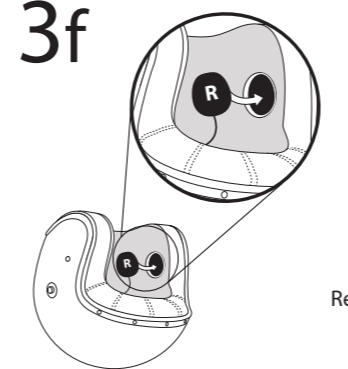

3g

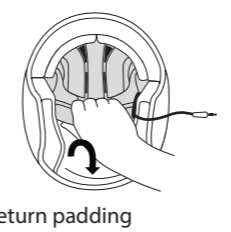

Option 1

Open face helmet installation התקנה בקסדה פתוחה

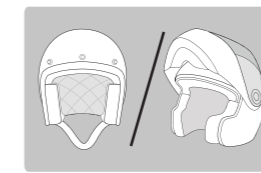

4 **B** x2 + **F**

4a **B** x2

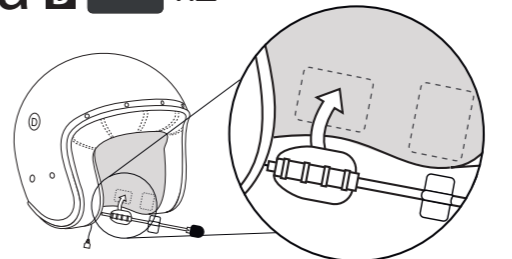

Place the mic to position the velcros הצמד את המיקרופון לסקוץ' הלבן

אפשרות ראשונה

4b **E**

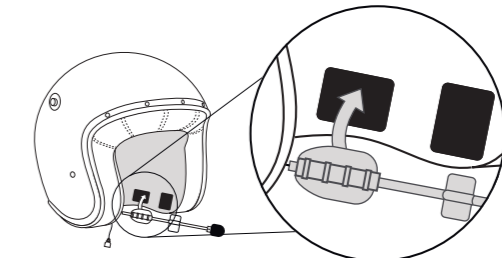

4c

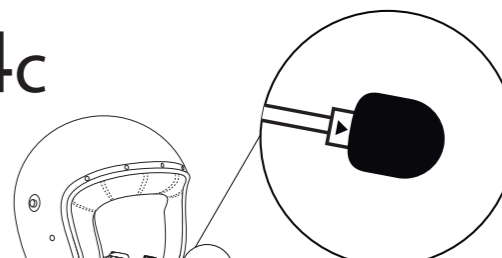

Arrow faces mouth חץ בכיוון הפה

Option 2

Full face helmet installation התקנה בקסדה מלאה

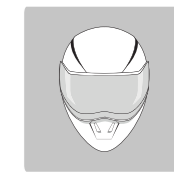

4* **D** **B**

4a* **B**

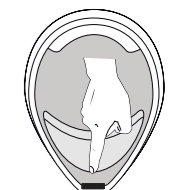

4b* **D**



4c*

